

REAL VALUE

POWERING AMERICAN BUSINESS
AND INDUSTRY FOR MORE THAN 40 YEARS



Commercial Solar Solutions

REAL VALUE



PROVIDING VALUE TO OUR PARTNERS AND CUSTOMERS

For decades, SolarWorld has lead the charge to make solar power the basis for a clean and reliable energy supply around the world. As a global company with more than 40 years of solar manufacturing experience, we are able to produce products at the highest quality, creating value for our customers, partners, shareholders, employees and society.

Quality is the best guarantee for consistent long-term performance of a solar system. By offering the most

advanced, durable and easy to install system solutions in the industry, we can ensure that any solar need can be fulfilled.

And as a leading manufacturer of solar energy products, we ensure sustainability plays a key role in all our business activities. We take great care to use ecological, economic and social resources responsibly. Come join us in our goal of creating a solar world.

SolarWorld Sunmodule – Quality modules made by America's largest solar manufacturer since 1975

With more than 40 years of manufacturing experience, SolarWorld has been a global market leader for decades and played a key role in the development of crystalline solar power technology that has become the industry standard. Today, at our manufacturing facility in Hillsboro, Oregon, we sustainably produce solar cells and assemble solar panels. Our state-of-the-art facility is fully automated, boasts 430 megawatts of cell capacity and 550 megawatts of panel capacity, and embodies our decades of proven solar experience. With global wafer production, SolarWorld ensures the highest quality levels throughout the entire production process. With at least 25 years of performance guaranteed, our quality ensures our customers are getting the most secure investment in the long run. SolarWorld makes your decision to go solar easy.

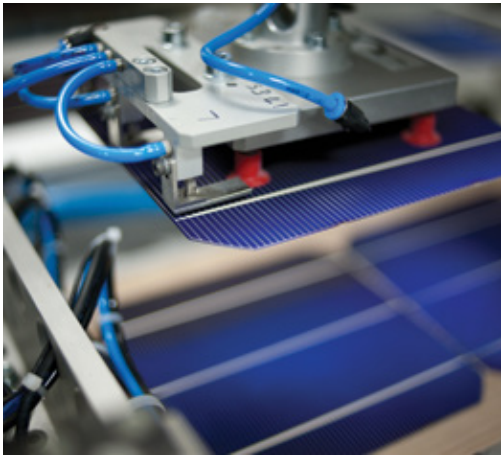



Industry-leading warranties – For your peace of mind

Our performance guarantees provide top value for our customers and confirm our high quality standards. With our 25-year linear performance guarantee on all Sunmodule Plus, Pro-Series and XL solar modules, our 30-year linear performance guarantee for our glass-glass Sunmodule Protect and our 10-year product workmanship warranty on all our solar panels, we deliver premium product performance and long-term security. Our history and warranties mean there is little chance you will ever have to worry about your system.

Guaranteed to deliver: We promise our customers reliability.

Linear performance guarantee*

- Linear performance guarantee from SolarWorld: Sunmodule Protect
- Linear performance guarantee from SolarWorld: Sunmodule Plus, Pro-Series and XL

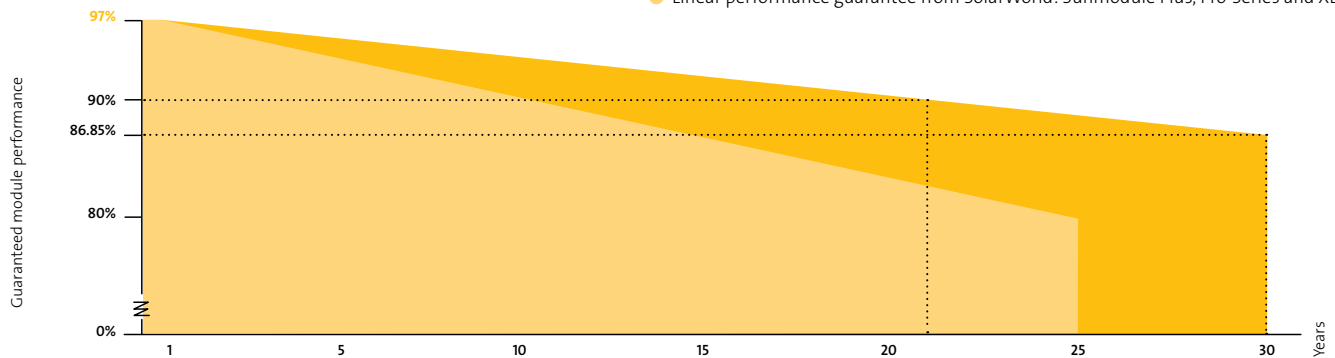

* in accordance with the applicable SolarWorld service certificate upon purchase • www.solarworld.com/warranty



Sunmodule[®] Plus, Pro-Series and XL

With our 25-year linear performance warranty, SolarWorld guarantees a maximum annual performance degradation of 0.7%. The warranty offers comprehensive protection for your investment in the long run.



Sunmodule[®] Protect

SolarWorld set new standards with the groundbreaking 30-year linear performance guarantee. A maximum degradation of just 0.35% per year ensures a guaranteed module performance of 90% after 21 years, and 86.85% after 30 years.

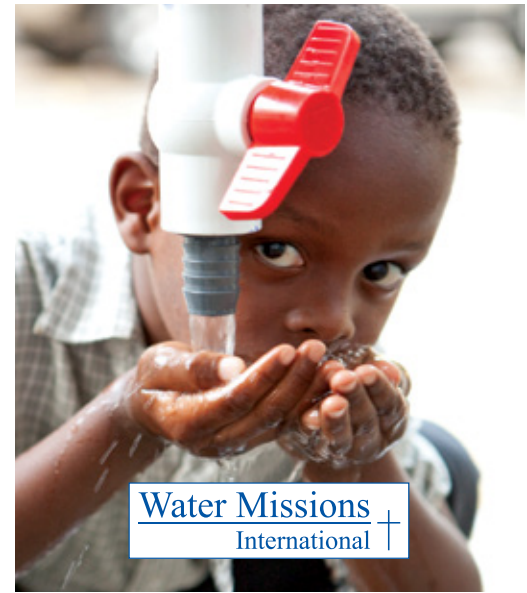
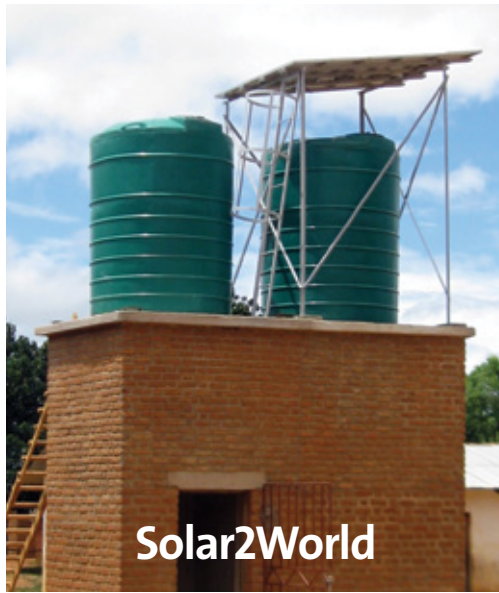

A passion for the environment, a commitment to community

Our commitment to sustainability goes deeper than our products. It starts with how we manufacture our products, how we treat our employees and what materials we choose, then extends outward to the communities we serve.

We believe that sustainability begins on the inside. We are proud to perform award-winning, eco-friendly practices all the way through our production process, from raw material procurement to the packaging of our finished products.

- » SolarWorld is a **Green Brands certificate winner** for 2014/2015. The Green Brands certificate is presented exclusively to brands with a **proven track record of environmentally sustainable actions** both inside and outside the company.
- » SolarWorld Sunmodules are **the first Green Certified solar panels** under the National Green Building Standard.
- » We have been **certified for our environmental management** since 2010 (ISO 14001).
- » We participate in the Carbon Disclosure Project with our goal to **reduce our carbon emissions by 8% p.a.** in CO₂e/Wp.
- » We have a commitment to the Global Reporting Initiative.

At the same time, we strive to give back to society through community programs, including Solar2Schools and Solar2World.

- » Our **Solar2Schools** initiative brings solar to our youth, giving them a firsthand opportunity to learn about renewable energies.
- » Our **Solar2World** initiative brings solar to those who otherwise would be without electricity.
- » Our partnership with **Water Missions International** brings clean, safe water to remote villages throughout the world.



How solar works

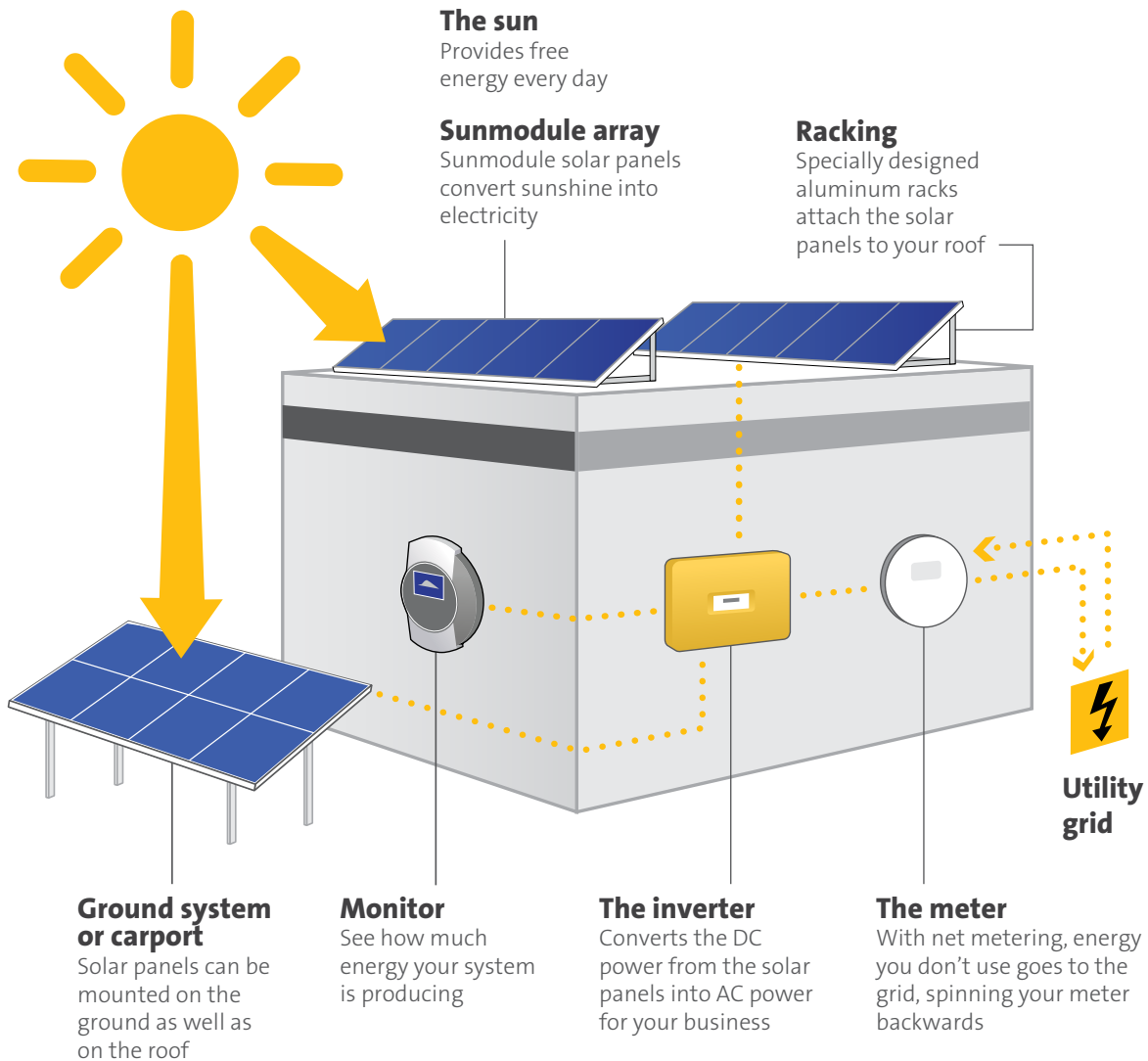

How net metering works

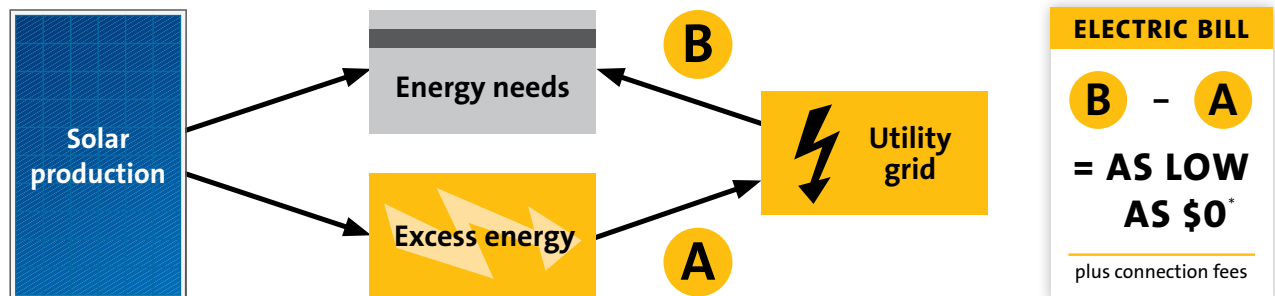

* Not all systems achieve 100% energy bill reduction.

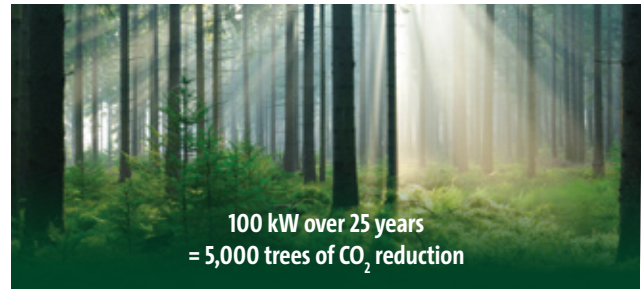

Great for your bottom line. Great for the planet.

Solar can dramatically reduce your operating costs by protecting your business from ever-increasing energy rates, all while decreasing your carbon footprint.

- » Solar systems have no moving parts and require minimal maintenance.
- » Our 25- and 30-year warranties leave you worry-free.
- » Many businesses achieve 15-25% in after-tax returns, generating thousands of dollars in savings.
- » Government incentives can reduce costs by 30% or more.
- » Financing options are available to create a cash positive project from day 1.
- » Solar can significantly reduce your operating costs.
- » Protects your company from escalating energy bills.
- » Meet government-mandated greenhouse gas emission targets.
- » Promote your company as a green business.

MONTHLY ELECTRICITY BILL SAVINGS

- Before solar
- With solar bill reduced by 72%

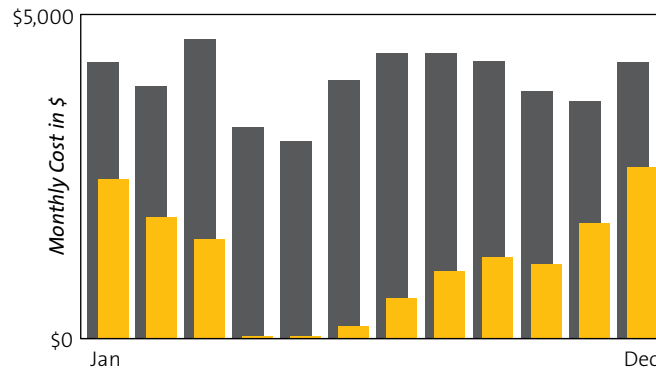

Charts are samples from real installations. Your results may vary.

INTERNAL RATE OF RETURN (IRR)

- Cash outflow
- Cash inflow
- Cumulative cash flow

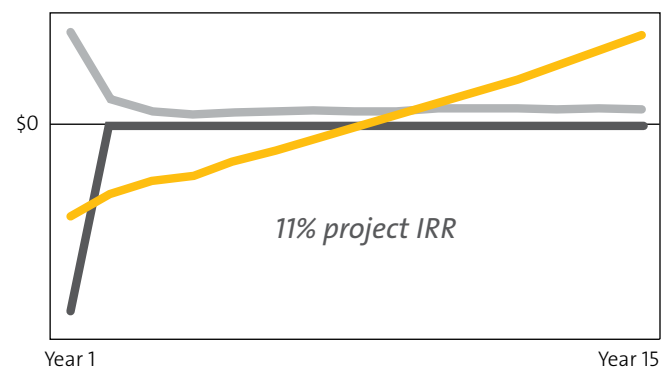



All solar panels are not created equal

Think all solar panels are the same? Think again. Maximize your return on investment with worry-free performance by selecting an experienced manufacturer that builds its products for the long-run.

Choose long-term production over efficiency

Many manufacturers are touting efficiency (power per square foot) as the most important feature of a solar panel. However, focusing only on efficiency may lead to reduced long-term performance, yielding less energy savings over the life of your system. These “efficient” panels often crowd the solar cells together and up against the frame. This can lead to shading from mounting components, excess accumulation of dirt over the cells, and reduced potential for light capture and energy production.

Your goal should be to only pay for the energy that will be produced over decades in a natural environment. So be sure to judge your purchase decision on real-world performance—not how much power a panel produces in optimal laboratory conditions.

Choose a proven technology

There are two main types of solar panels currently available on the market: crystalline silicon, like SolarWorld panels, and thin-film. Crystalline silicon panels have a significantly higher energy yield than thin-film panels. Unlike thin-film, crystalline solar panels have a proven real-life track record of over four decades, making them the preferred technology of choice for developers, utilities, government, business and agriculture.

Choose an experienced manufacturer

There are hundreds of young start-up solar companies today, and it’s tough to know with whom to do business. Given that a solar module can produce energy for decades, be sure to select a manufacturer that will be around to honor warranties and service commitments.



Sunmodule Plus



Sunmodule Protect



Sunmodule Pro-Series

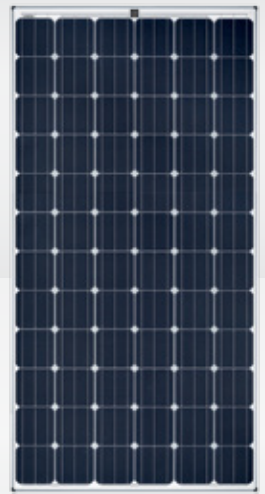

Sunmodule XL

Sunmodule[®]

SolarWorld's Sunmodule solar panels are designed, tested, and manufactured with attention to every detail so you benefit from maximum energy generation.

Designed for the real world

In the real world, it rains, it snows and the wind blows. Our panel design is artfully configured to **ensure high performance during decades of exposure to real-world conditions**. This is exactly why our solar panels are actively converting sunlight to energy all over the world — on homes, businesses, farms, parking lots — just about anywhere the sun shines.

Made from the highest quality materials

Solar cells are the engines that power solar panels, which is why we don't trust anyone else to make them for us. To guarantee peak performance and reliability, we apply our stringent quality requirements on all our materials—and very few suppliers are able to meet our strict standards—then **we make all our solar cells and panels in-house**.

Call us control freaks, but our proprietary components and processes ensure we consistently exceed industry standards.

And to be true to our belief in American manufacturing, we source as many of these components in the U.S. as we can.

A promise you can believe in

Many companies claim to have high-power solar panels, yet they are rarely available to the average business owner. With the capacity to produce more than 430 megawatts of our high-powered cells and assemble more than 550 megawatts of our high-quality panels right here in the U.S., and over a gigawatt of each globally, we know we can deliver what we promise.





Mauritson Winery • Healdsburg, California

Sloped-roof systems

For sloped-roof installation, a penetrating roof-mount system is ideal. SolarWorld proudly offers our Sunfix plus mounting system which has been designed to perform optimally with SolarWorld's Sunmodule panels.

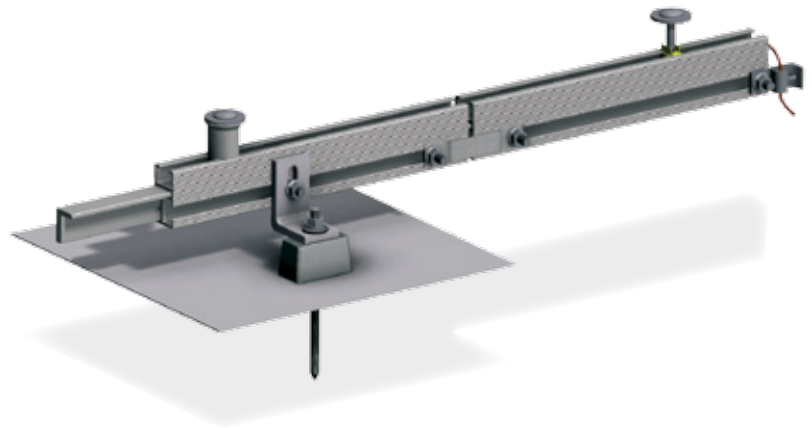

Sunfix^{plus}

Designed by SolarWorld for easy installation and maximum solar performance, American-made Sunfix plus racking ensures your system will remain securely in place during its entire life. Sunfix plus can be used on flat or sloped rooftops, and is secured by bolting into structural beams without affecting the integrity of your roof. A properly installed system is guaranteed to keep your roof as sound as it was prior to installation.

PRODUCT BENEFITS

- » For pitched roofs up to 45°, as well as walls
- » Pre-assembled top clamps, pre-cut rail lengths and a unique clamp positioning feature saves on labor costs
- » Easily adaptable to most roof types including: composition shingle, standing metal seam, flat or curved concrete tile
- » Sturdy design allows for 170 mph wind load and up to 50 lb/ft² snow load (ASCE 7-05).
- » Black finish available to match SolarWorld's black Sunmodules
- » Optional Sunskirt for installation aesthetics or to comply with fire code requirements (UL-certified)





Anderson Crossing Apartments • Westerville, Ohio



Ventura Commercial Square • Ventura, California



Harvestime Foods • Chicago, Illinois



Limerock Court Associates • State College, Pennsylvania



Ohio University Coal Storage Building - Athens, Ohio

Flat and low-slope roof systems

Ideal for flat rooftops, a ballasted solar system angles aligns the panels for optimal solar production with little or no roof penetration required. SolarWorld has partnered with Panel Claw to offer the industry's best flat-roof installation solution.

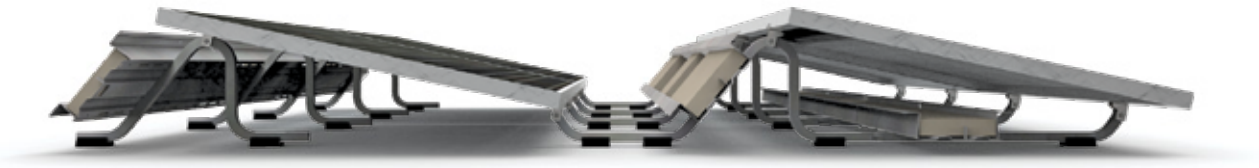

PanelClaw Polar Bear III

The PanelClaw Polar Bear® III mounting system is the ideal solution for mounting solar panels on low-sloped commercial rooftops. The Polar Bear III reduces potential long-term roof damage with fully captured ballast, integrated roof protection pads and a system design that allows for free water flow.

PRODUCT BENEFITS

- » Three major components, light-weight and easy to assemble
- » Tilt-up feature to facilitate must-have access to roof, wiring and maintenance
- » Wire management options available
- » UL 2703 certified for electric bonding and grounding
- » 25-year warranty
- » Integrated grounding
- » High wind and snow loading capacity
- » Fire certified Class A





Avidan Management • Edison, New Jersey



UT Medical Center • San Antonio, Texas



Gas Station • Harrisburg, Pennsylvania



Wayne's Inc • Morgan, Minnesota



Ground-mounted systems

Standard ground mounts

Utilize open square footage to generate power for nearby buildings and equipment. A ground mount with battery storage can bring power to areas that were previously “off-the-grid.” SolarWorld has a variety of ground mount products to accommodate any location or environment.

Carports

A solar carport structure provides the dual benefit of energy generation and vehicle-cooling shade. Add optional charging stations for a fleet of electric vehicles. The solar system can offset new EV energy loads.





San Diego Ice Arena • San Diego, California



Portland Development Commission • Portland, Oregon



Welcome to Las Vegas Sign • Las Vegas, Nevada



Cincinnati Zoo • Cincinnati, Ohio



Find out more

Do you have any questions about SolarWorld's quality standards or individual products? If so, don't hesitate to contact us. We will gladly provide you with additional information and show you exactly how SolarWorld can prepare you for the solar future today.

SIMPLY CALL US OR SEND US AN EMAIL:

PHONE: 855-GO-SOLAR

 CUSTOMERSUPPORT@SOLARWORLD.COM

SolarWorld Americas Inc.
25300 NW Evergreen Rd
Hillsboro, Oregon 97124, U.S.A.
customersupport@solarworld.com

solarworld.com